

Rollomatic $\varnothing 25$ mm // Schaft $\varnothing 20$ mm // RS $\varnothing 50$ mm

Passend auf Rollomatic Werkzeugschleifmaschinen für Ringsatz $\varnothing 50$ mm

SSA $\varnothing 25$ mm // $\varnothing 20$ mm // RS $\varnothing 50$ mm

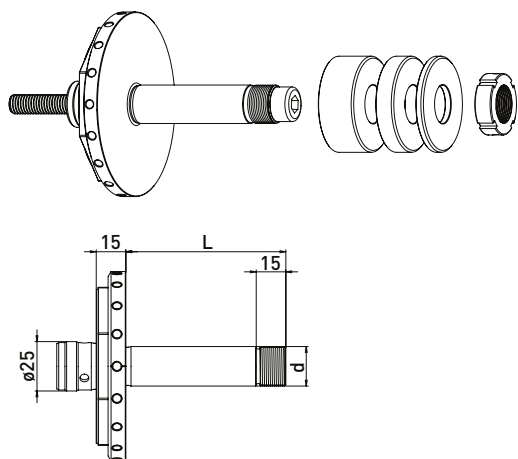

Lieferung bestückt:
Ringsatz $\varnothing 50$ mm, Spannschraube M10 und Spannmutter

Best.-Nr.	d	L	Ringsatz $\varnothing 50$ mm		
			B 20	B 10	B 4
300150412	20	50	-	2	4
300150422	20	81	1	3	4

Zubehör Rollomatic Schleifscheibenaufnahme $\varnothing 25$ mm // Schaft $\varnothing 20$ mm // RS $\varnothing 50$ mm

Best.-Nr.	Bezeichnung
350040051	Hakenschlüssel mit Nase 30 - 32 mm



Best.-Nr.	Bezeichnung
350011520	Distanzring Rollomatic $\varnothing 50$ x $\varnothing 20$ x 20
350011510	Distanzring Rollomatic $\varnothing 50$ x $\varnothing 20$ x 10
350011504	Distanzring Rollomatic $\varnothing 50$ x $\varnothing 20$ x 4
350020120	Präzisionsstellmutter MRR20x1 M20x1,0- $\varnothing 32$ x 10
350015003	Stützscheibe $\varnothing 50$ x $\varnothing 75$ x $\varnothing 20$ x 6

Rollomatic $\varnothing 25$ mm // Schaft $\varnothing 31,75$ mm (1 $\frac{1}{4}$)

Passend auf Rollomatic Werkzeugschleifmaschinen

SSA $\varnothing 25$ mm // $\varnothing 31,75$ mm

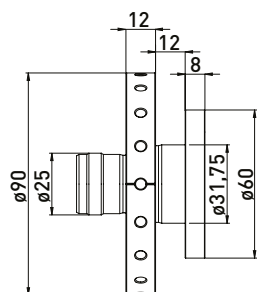
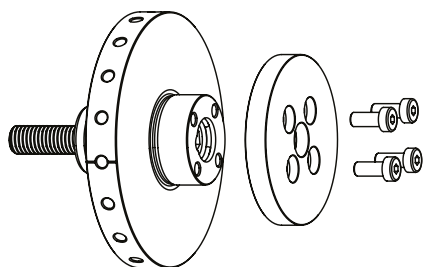

Lieferung bestückt:

Spannflansch, 4 Stück Zylinderschrauben M5 x 12 und
Spannschraube M10

Best.-Nr.	Bezeichnung
300150510	Schleifscheibenaufnahme Rollomatic $\varnothing 31,75$ x 11

Rollomatic $\varnothing 25$ mm // Schaft $\varnothing 31,75$ mm (1 $\frac{1}{4}$) // RS $\varnothing 60$ mm

Passend auf Rollomatic Werkzeugschleifmaschinen für Ringsatz $\varnothing 60$ mm

SSA $\varnothing 25$ mm // $\varnothing 31,75$ mm (1 $\frac{1}{4}$) // RS $\varnothing 60$ mm

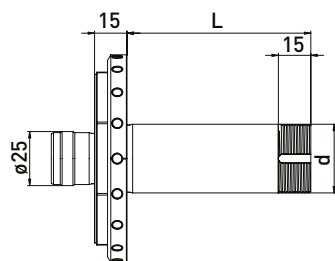
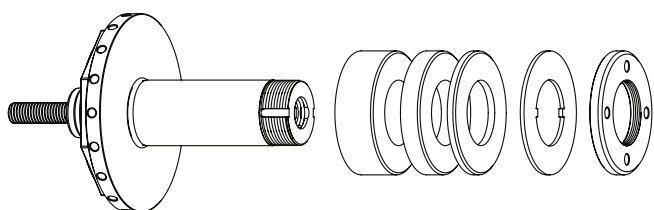







Lieferung bestückt:

Ringsatz $\varnothing 60$ mm, Spannschraube M10, Sicherungsblech und Spannmutter

Best.-Nr.	d	L	Ringsatz $\varnothing 60$ mm		
			B 20	B 10	B 4
300150212	31,75	50	-	2	4
300150222	31,75	85	2	2	3
300150232	31,75	115	3	3	3

Zubehör Rollomatic Schleifscheibenaufnahme $\varnothing 25$ mm // $\varnothing 31,75$ mm (1 $\frac{1}{4}$) // RS $\varnothing 50$ mm

Best.-Nr.	Bezeichnung
350040020	Spannmutterschlüssel TK45 für $\varnothing 32$ 

Best.-Nr.	Bezeichnung	
350011620	Distanzring Rollomatic $\varnothing 60 \times \varnothing 31,75 \times 20$	
350011610	Distanzring Rollomatic $\varnothing 60 \times \varnothing 31,75 \times 10$	
350011604	Distanzring Rollomatic $\varnothing 60 \times \varnothing 31,75 \times 4$	
350030060	Sicherungsblech $\varnothing 60 \times \varnothing 32 \times 1,8$	
350020066	Spannmutter $\varnothing 60 \times 6 \times M32 \times 1,5$	

Rollomatic $\varnothing 25$ mm // Schaft $\varnothing 32$ // RS $\varnothing 60$ mm

Passend auf Rollomatic Werkzeugschleifmaschinen für Ringsatz $\varnothing 60$ mm

SSA $\varnothing 25$ mm // $\varnothing 32$ mm // RS $\varnothing 60$ mm

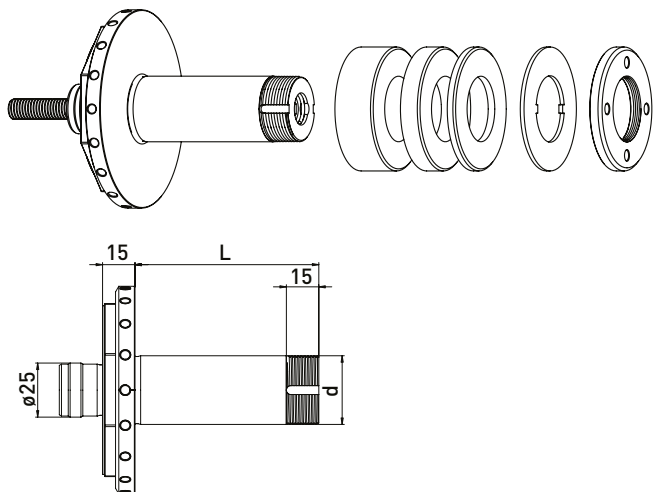







Lieferung bestückt:

Ringsatz $\varnothing 60$ mm, Spannschraube M10, Sicherungsblech und Spannmutter

Best.-Nr.	d	L	Ringsatz $\varnothing 60$ mm		
			B 20	B 10	B 4
300150312	32	50	-	2	4
300150322	32	85	2	2	3
300150332	32	115	3	3	3

Zubehör Rollomatic Schleifscheibenaufnahme $\varnothing 25$ mm // Schaft $\varnothing 32$ mm // RS $\varnothing 50$ mm

Best.-Nr.	Bezeichnung
350040020	Spannmutterschlüssel TK45 für $\varnothing 32$ 

Best.-Nr.	Bezeichnung
350011620	Distanzring Rollomatic $\varnothing 60 \times \varnothing 31,75 \times 20$ 
350011610	Distanzring Rollomatic $\varnothing 60 \times \varnothing 31,75 \times 10$ 
350011604	Distanzring Rollomatic $\varnothing 60 \times \varnothing 31,75 \times 4$ 
350030060	Sicherungsblech $\varnothing 60 \times \varnothing 32 \times 1,8$ 
350020066	Spannmutter $\varnothing 60 \times 6 \times M32 \times ww1,5$ 

Rollomatic $\varnothing 25$ mm // gestufter Schaft $\varnothing 32$, $\varnothing 30$, $\varnothing 40$ und $\varnothing 50$ mm

Passend auf Rollomatic Werkzeugschleifmaschinen

SSA $\varnothing 25$ mm // gestufter Schaft

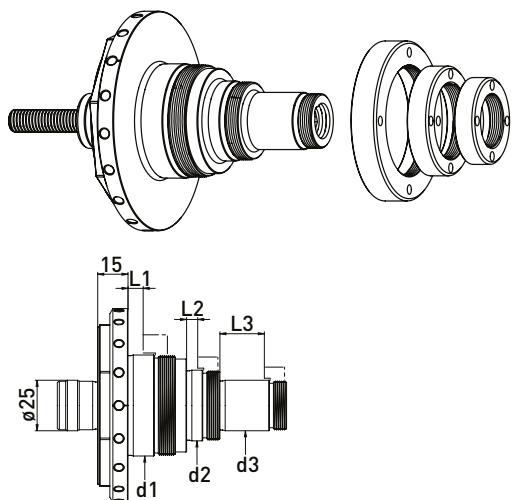

Lieferung bestückt:

je 1 Stück Spannmutter $\varnothing 38$ (350020110), $\varnothing 48$ (350020111), $\varnothing 70$ (350020113) und Spannschraube M10

Best.-Nr.	L1	L2	L3	d1	d2	d3
300150111	11,5	5,5	5,5	50	35	25
300150121	7,5	5,5	22	50	35	25

Lieferung bestückt:

je 1 Stück Spannmutter $\varnothing 38$ (350020110), $\varnothing 58$ (350020112) und Spannschraube M10





Best.-Nr.	L1	L2	L3	d1	d2	d3
300150131	11,5	5,5		40	25	



Lieferung bestückt:

je 1 Stück Spannmutter $\varnothing 38$ (350020110), $\varnothing 70$ (350020113) und Spannschraube M10

Best.-Nr.	L1	L2	L3	d1	d2	d3
300150141	11,5	5,5		50	25	

Zubehör Rollomatic Schleifscheibenaufnahme $\varnothing 25$ mm // gestufter Schaft $\varnothing 32$, $\varnothing 30$, $\varnothing 40$ und $\varnothing 50$ mm

Best.-Nr.	Bezeichnung	für d
350020110	Spannmutter Rollomatic $\varnothing 38 \times \varnothing 25 \times 10$ M24 x 1	25 
350020111	Spannmutter Rollomatic $\varnothing 48 \times \varnothing 35 \times 10$ M34 x 1	35 
350020112	Spannmutter Rollomatic $\varnothing 58 \times \varnothing 40 \times 11$ M39 x 1	40 
350020113	Spannmutter Rollomatic $\varnothing 70 \times \varnothing 50 \times 12$ M49 x 1	50 

Best.-Nr.	Bezeichnung
350016001	Distanzring $\varnothing 38 \times \varnothing 25 \times 5$ 
350016002	Distanzring $\varnothing 58 \times \varnothing 40 \times 5$ 
350016003	Distanzring $\varnothing 70 \times \varnothing 50 \times 5$ 

Rollomatic HSK-E50 // Schaft $\varnothing 20$ mm // RS $\varnothing 50$ mm

Passend auf Rollomatic Werkzeugschleifmaschinen für Ringsatz $\varnothing 50$ mm

SSA HSK-E50 // $\varnothing 20$ mm // RS $\varnothing 50$ mm

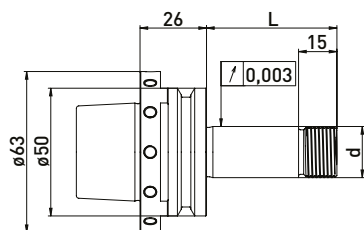
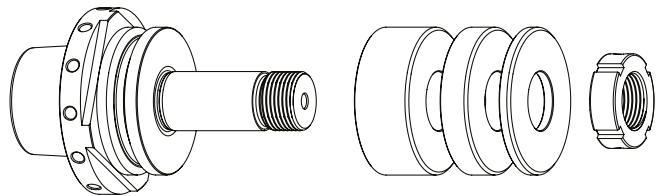

Lieferung bestückt:
Ringsatz $\varnothing 50$ mm und Spannmutter

SSA HSK-E50 // $\varnothing 20$ mm // ohne RS

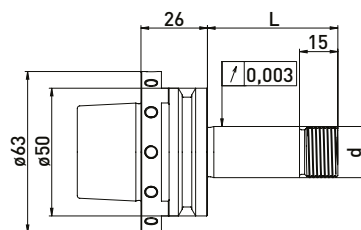
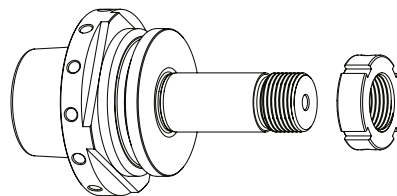

Lieferung bestückt:
mit Spannmutter

Ringsatz $\varnothing 50$ mm

Best.-Nr.	HSK	d	L	Ringsatz $\varnothing 50$ mm		
				B 20	B 10	B 4
300150612	HSK-E50	20	51	1	1	2
300150632	HSK-E50	20	81	2	2	2

Best.-Nr.	HSK	d	L
300150611	HSK-E50	20	51
300150631	HSK-E50	20	81

Zubehör Rollomatic Schleifscheibenaufnahme SSA HSK-E50 // Schaft $\varnothing 20$ mm // RS $\varnothing 50$ mm

Best.-Nr.	Bezeichnung
350040051	Hakenschlüssel mit Nase 30 - 32 mm



Best.-Nr.	Bezeichnung
350011520	Distanzring Rollomatic $\varnothing 50 \times \varnothing 20 \times 20$
350011510	Distanzring Rollomatic $\varnothing 50 \times \varnothing 20 \times 10$
350011504	Distanzring Rollomatic $\varnothing 50 \times \varnothing 20 \times 4$
350020121	Präzisionsstellmutter MRR20 x 1,5 M20 x 1,5 $\varnothing 32 \times 10$
350015003	Stützscheibe $\varnothing 50 \times \varnothing 75 \times \varnothing 20 \times 6$

